



9625-9500

Multiplicador de binário manual com placa de reação



DETALHES DO PRODUTO

- O sistema de bloqueio de roquete contém as forças geradas durante o aperto, o que torna possível o que, de outra forma, seria difícil, perigoso ou mesmo impossível
- A placa de reação com ponto deslizante permite escolher o melhor ponto de reação para o trabalho em questão
- Amplitude de cobertura, binário máximo de saída até 9500 Newton Meter
- Utilize sempre com a chave dinamométrica (CW e CCW) para evitar exceder o binário máximo do multiplicador
- Precisão $\pm 4\%$
- Fornecido em saco de tecido portátil até 3400 Newton Meter e em mala rígida com rodas nos tamanhos superiores
- Fabricado no Reino Unido

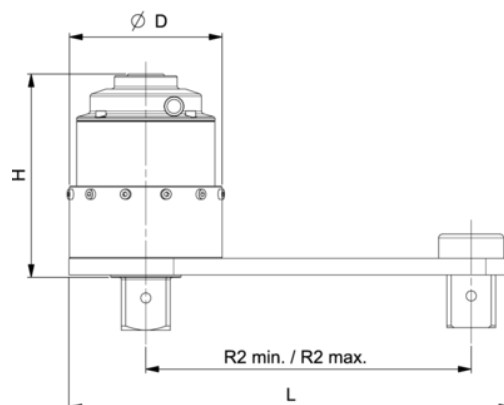











Follow the Fish!



ATRIBUTOS DO PRODUTO

Produto: **9625-9500**

 MAX Nm	9500 N·m	 in	3/4 in	 : 	27:1
 MAX Nm	351 N·m		1.1/2 in		184 mm
	162 mm		448 mm	R2 min mm	175 mm
R2 max mm	351 mm		25.700 kg		

Follow the Fish!

