



1475KXL12RED

**Carrinho de ferramentas 40"
Classic C75 com 12 gavetas
vermelhas 1100 mm x 501 mm x
50 mm**



DETALHES DO PRODUTO

- Gavetas de abertura completa com sistema de fecho Lock&Go
- Armação reforçada de parede dupla com pontos de soldadura extra
- Sistema de fecho redondo antirroubo
- Rodas de borracha suaves e silenciosas
- Acessórios disponíveis
- Revestimento de pó à prova de riscos disponível em duas cores: laranja e preto

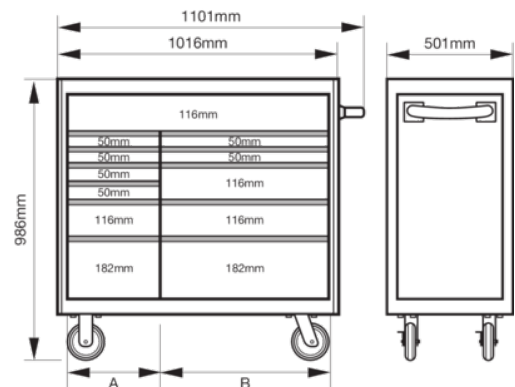









Follow the Fish!



ATRIBUTOS DO PRODUTO

Produto: **1475KXL12RED**

	986 x 501 x 1100 mm		1100 kg		12
	445 mm		880 mm	A	284 mm
B	543 mm		30 kg		150 mm
	50 mm		111 kg	RAL	3001

Follow the Fish!

