



**1472K6RED**  
**Carrinho E72**



DETALHES DO PRODUTO



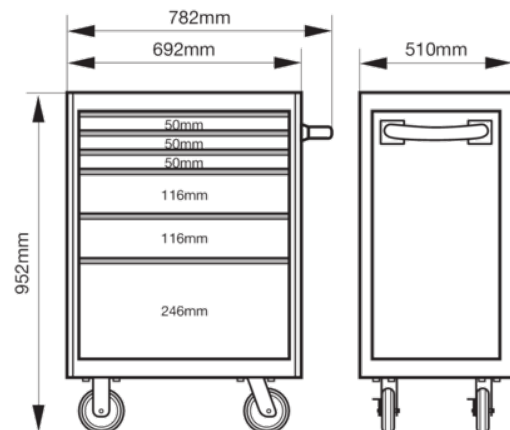





- Amortecedores de canto com proteção de choque
- Gavetas que podem abrir completamente
- Construção de caixa de parede dupla em aço sólido
- Sistema de fecho redondo antirroubo
- Sistema modular de acessórios Xpand disponível
- Rodas de borracha para qualquer superfície
- Revestimento de pó à prova de riscos disponível em quatro cores: laranja, preto, azul e vermelho



Follow the Fish!



## ATRIBUTOS DO PRODUTO

Produto										RAL
<b>1472K6RED</b>	952 x 510 x 782 mm	600 kg	6	445 mm	543 mm	30 kg	125 mm	30 mm	68 kg	3001

Follow the Fish!

