



**BH3HD20000A**

## **Preguiça de 20 T para trabalhos pesados**



### DETALHES DO PRODUTO



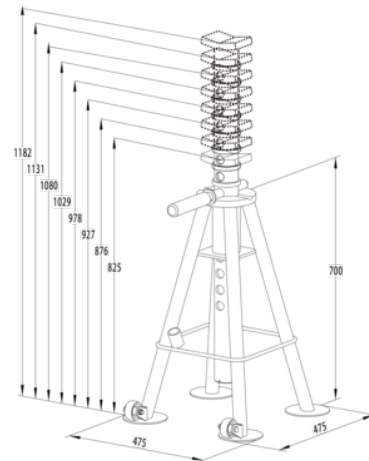



- Preguiça de 20 T especialmente concebido para aplicações de trabalhos pesados
- Estrutura reforçada para torná-la mais segura ao suportar cargas
- Sistema de fecho de pino de segurança com Cabo de borracha
- Altura máxima alcançável de 1150 mm
- Base de borracha especial em V para facilitar e garantir as operações de carga
- Equipada com duas rodas para transporte confortável
- Aprovação TÜV e com certificação GS
- Vendida individualmente



**Follow the Fish!**



## ATRIBUTOS DO PRODUTO

Produto						
<b>BH3HD20000A</b>	20000 kg	825 mm	1150 mm	47,5 x 47,5 cm		38.5 kg

Follow the Fish!

