



**BH1EU3000**

**Macaco com capacidade até 3000Kg**



## DETALHES DO PRODUTO

- Macaco de rodas com capacidade de 3 t
- Elevação hidráulica manual
- Pistões duplos permitem 7 cursos de bomba para atingir a altura máxima
- Pistão com proteção contra poeira
- Rodas de nylon
- Base de borracha
- Tabuleiro de armazenamento
- Válvula de pressão de segurança
- Válvula de abaixamento de segurança



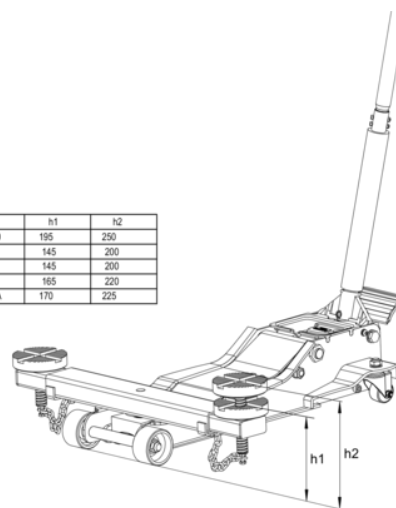







Ref.	h1	h2
BH1EU3000	195	250
BH11500	145	200
BH12000	145	200
BH13000	165	220
BH13000QA	170	225



**Follow the Fish!**



## ATRIBUTOS DO PRODUTO

Produto										
<b>BH1EU3000</b>	3000 kg	130 mm	462 mm	617 mm	6	120 mm	617 mm	340 mm	1400 mm	31 kg

**Follow the Fish!**

