



### 9505-TM

## Multiplicador de binário manual com braços de reação angular e reto



### DETALHES DO PRODUTO

- A gama abrange um valor de torque máximo de 2700 N.m
- Utilizar sempre com chave dinamométrica (sentidos horário e anti-horário) para evitar ultrapassagens do binário máximo do multiplicador
- Precisão de  $\pm 4\%$
- Fornecida com braços de reação reto e angular
- Fornecida em caixa portátil moldada por sopro
- Fabricada no Reino Unido

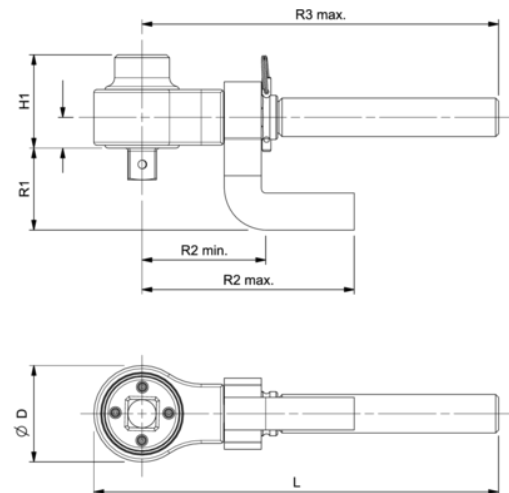









Follow the Fish!



## ATRIBUTOS DO PRODUTO

Produto: **9505-TM**

 MAX Nm	2700 N·m		1 in		5:1
 MAX Nm	540 N·m	 in	3/4 in	<b>D</b>	108 mm
R3 max mm	344 mm	H1 mm	100 mm	<b>L</b>	210 mm
R2 max mm	212 mm	R2 min mm	140 mm	R1 mm	85 mm
 kg	3.8 kg	 kg	1.06 kg	 kg	1.36 kg
 kg	3.700 kg				

Follow the Fish!

