



### 1475KXXL8CWTSS

**53" spesialverktøyvogn med 8 skuffer og sideskap 1505 mm x 500 mm x 1218 mm**



#### PRODUKTDETALJER

- Verktøyvogn med 8 skuffer og ekstra stor kapasitet
- Lock & Go låsesystem forhindrer at skuffene åpnes når vognen flyttes.
- Skuffer med lister i aluminium
- Pulverlakkert overflate som hindrer riper
- Solid stålkonstruksjon: Rammeverket med doble vegger er forsterket med strategisk plasserte sveisepunkter
- Topp i rustfritt stål
- Lydløse gummihjul på 320 mm x 85 mm sikrer maksimal stabilitet
- Skuffenes innermål: (2 x) 880 mm x 440 mm x 50 mm, (3 x) 880 mm x 440 mm x 115 mm, (1 x) 880 mm x 440 mm x 180 mm
- Med doble vegger: Hvis ytterveggen blir skadet i en kollisjon, sikrer den doble veggen at skuffene alltid kan åpnes
- Solid og sikkert, rundt låsesystem beskytter vognen mot tyveri

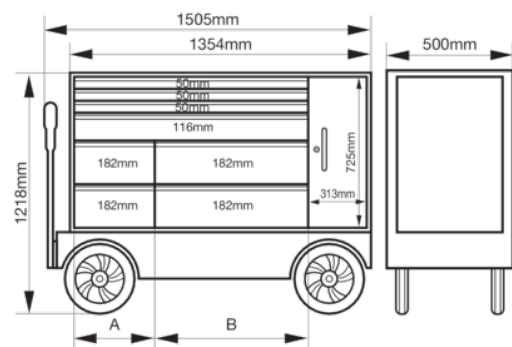









Follow the Fish!



PRODUKTEGENSKAPER

Produkt: **1475KXXL8CWTSS**

	1218 x 500 x 1505 mm		1089 kg		8
	445 mm		880 mm	<b>A</b>	284 mm
<b>B</b>	543 mm		45 kg		310 mm
	95 mm		212.20 kg	<b>RAL</b>	2009

Follow the Fish!

