



BH13000 Garasjejekk 3 T









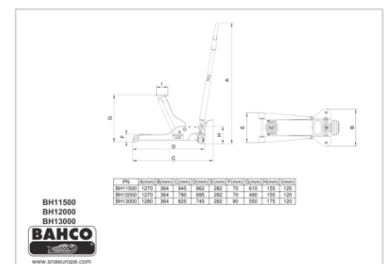
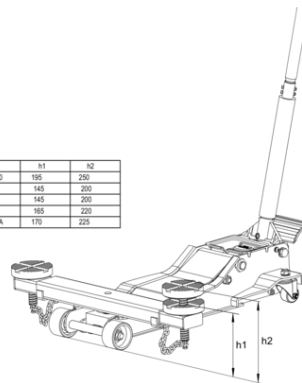



PRODUKTDETALJER

- 3 T garasjejekk designet for å løfte et bredt spekter av standard kjøretøy
- 90 mm inngangshøyde og 552 mm makshøyde
- Dobbelt stempelsystem reduserer antall nødvendige pump med 50 %
- Ekstra stor fotpedal og avrundet håndtak i komposittmateriale for rask, trygg og komfortabel bruk
- Forbedret beskyttelse mot overbelastning
- Stålhjul belagt med PU (polyuretan) sikrer lang holdbarhet og mindre støy
- Støvbeskyttelse for å unngå skade på stempler og fjær
- Gummisadel som beskytter kjøretøyet og reduserer risikoen for at det sklir av
- Skumplast på håndtaket beskytter kjøretøyet karosseri mot riper
- Utrustet med sikkerhetsventil og kontrollert hastighet ved nedsenking
- CE-sertifisert i henhold til 2006/42/EC + BS EN1494

Stør	h1	h2
BH1EJ3000	185	250
BH11500	145	200
BH13000	165	200
BH13000	165	225
BH13000GA	170	225



PRODUKTEGENSKAPER

Produkt										
BH13000	3000 kg	90 mm	552 mm	825 mm	+/- 11	119 mm	x	X	1280 x 364 x 825 mm	48.5 kg

