



89222CR/96255CR

**Kompakt manuell momentforsterker
med vinklet motholdsarm**



PRODUKTDETALJER



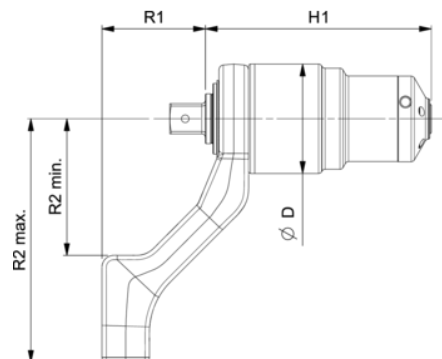



- Skrallelåsesystem tilgjengelig på alle forsterkere
- Dekker maks. utgangsmoment opptil 7000 Nm
- Bruk alltid momentnøkkel (med og mot klokken) for å unngå at forsterkerens maksimumsmoment overskrides
- Nøyaktighet $\pm 4\%$
- Skrallelåsesystem tar hånd om kreftene som skapes under strammingen, og muliggjør arbeid som ellers ville vært vanskelig, farlig eller umulig.
- Kompakte dimensjoner gir god tilgang til arbeidet og enkel, trygg håndtering
- Lav vekt og god momentkapasitet
- Leveres med vinklet motholdsarm
- Leveres i bærbar plastboks med skuminnlegg
- Hver forsterker leveres med sitt eget unike kalibreringssertifikat som muliggjør presis beregning av inngangsmomentet når det stilles store krav til nøyaktighet
- Produsert i Storbritannia









Follow the Fish!









Produkt: 8922CR-1000

 1000 Nm	 in	1/2 in		22.2:1
 45 Nm		3/4 in	D	52 mm
H1 mm	R1 mm	58 mm	R2 min mm	71 mm
R2 max mm	 kg	0.9 kg	 kg	1.4 kg







Produkt: 9527CR-2000

 2000 Nm	 in	1/2 in		27:1
 74 Nm		1 in	D	72 mm
H1 mm	R1 mm	72 mm	R2 min mm	91 mm
R2 max mm	 kg	0.7 kg	 kg	3.2 kg

Produkt: 9525CR-4000

 4000 Nm	 in	1/2 in		25:1
 160 Nm		1 in	D	92 mm
H1 mm	R1 mm	87 mm	R2 min mm	115 mm
R2 max mm	 kg	1.4 kg	 kg	5.4 kg

Produkt: 96255CR-7000

 7000 Nm	 in	1/2 in		25.5:1
 274 Nm		1.1/2 in	D	119 mm
H1 mm	R1 mm	117 mm	R2 min mm	151 mm
R2 max mm	 kg	2.1 kg	 kg	9.3 kg

