



**9527CR-2000**

## **Kompakt manuell momentforsterker med vinklet motholdsarm**



### PRODUKTDETALJER

- Skrallelåsesystem tilgjengelig på alle forsterkere
- Dekker maks. utgangsmoment opptil 7000 Nm
- Bruk alltid momentnøkkel (med og mot klokken) for å unngå at forsterkerens maksimumsmoment overskrides
- Nøyaktighet  $\pm 4\%$
- Skrallelåsesystem tar hånd om kreftene som skapes under strammingen, og muliggjør arbeid som ellers ville vært vanskelig, farlig eller umulig.
- Kompakte dimensjoner gir god tilgang til arbeidet og enkel, trygg håndtering
- Lav vekt og god momentkapasitet
- Leveres med vinklet motholdsarm
- Leveres i bærbar plastboks med skuminnlegg
- Hver forsterker leveres med sitt eget unike kalibreringssertifikat som muliggjør presis beregning av inngangsmomentet når det stilles store krav til nøyaktighet
- Produsert i Storbritannia

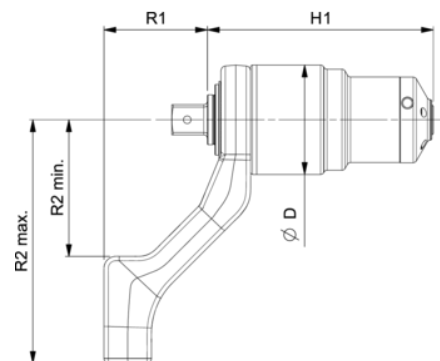









**Follow the Fish!**



PRODUKTEGENSKAPER

Produkt: **9527CR-2000**

 MAX Nm	2000 N·m	 in	1/2 in		27:1
 MAX Nm	74 N·m		1 in	 D	72 mm
<b>H1</b> mm	154 mm	<b>R1</b> mm	72 mm	<b>R2 min</b> mm	91 mm
<b>R2 max</b> mm	166 mm	 kg	1.4 kg	 kg	3.2 kg

Follow the Fish!

