



**9526B-4500**

## Momentforsterker med rett motholdsarm for manuelle nøkler



### PRODUKTDETALJER

- Skrallelåsesystem tilgjengelig på alle forsterkere
- Vinkelmåler for enkel moment- og vinkelstramming
- Dekker maks. utgangsmoment opptil 4500 Nm
- Bruk alltid momentnøkkel (med og mot klokken) for å unngå at forsterkerens maksimumsmoment overskrides
- Nøyaktighet  $\pm 4\%$
- Skrallelåsesystem tar hånd om kreftene som skapes under strammingen, og muliggjør arbeid som ellers ville vært vanskelig, farlig eller umulig
- Leveres med rett motholdsplate
- Leveres i bærbar plastboks med skuminnlegg
- Sant 15,5:1 (3000 Nm) eller 26:1 (4500 Nm) forhold for momentforsterking tillater bruk av en mindre nøkkel
- Produsert i Storbritannia

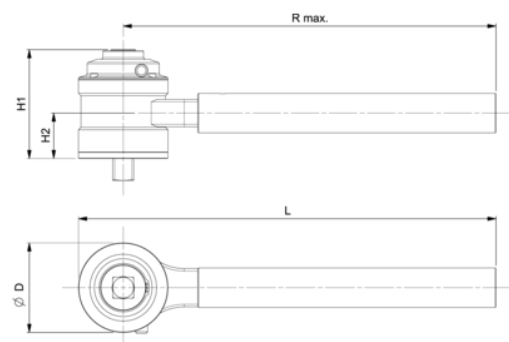







**Follow the Fish!**



PRODUKTEGENSKAPER

Produkt: **9526B-4500**

 MAX Nm	4500 N·m	 in	1/2 in		27:1
 MAX Nm	166 N·m	 mm	1 in	<b>D</b>	108 mm
<b>H1</b> mm	149 mm	<b>H2</b> mm	55 mm	<b>L</b>	504 mm
<b>R max</b> mm	450 mm	 kg	1.9 kg	 kg	

Follow the Fish!

