

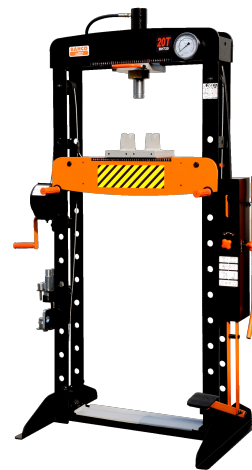

**BH720/BH730/BH750**  
**Presse 20 T, 30 T og 50 T**



## PRODUKTDETALJER

- 20, 30 og 50 T verkstedpresser
- Ekstra kraftig struktur med eksklusiv design og avrundede former
- Stor trykkmåler med glyserin som er lettavlest i behagelig øyehøyde
- To stegs pumpe og innebygget sikkerhetsventil mot overbelastning
- Hardkrommet stempel
- Rask å bruke takket være pedalen og håndtaket
- Linjaler som forenkler sentrering av stampelet i forhold til arbeidsstykket
- To V-blokker er inkludert. Kan brukes enten med den V-formede siden eller den flate siden avhengig av behovet
- Autosentrerte splinter for bordet
- Enkel heving og senking av pressbordet takket være vinsjen med vribart håndtak
- Pedal med antiskli-gummibeskyttelse
- Dorsett med 8 stk dorer og mothold er inkludert
- Isolerte håndtak
- Trau for oppbevaring av verktøy i bunnen
- CE-sertifisert i henhold til 2006/42/EC

**Follow the Fish!**



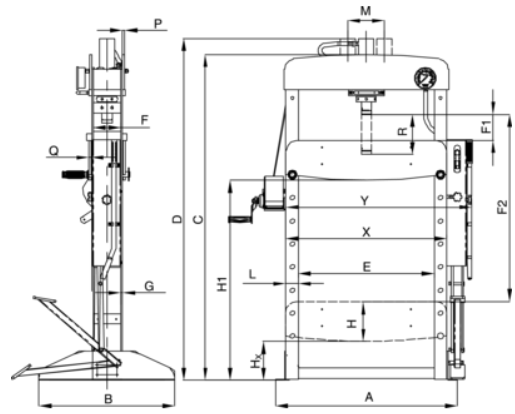

**BH720**

Model	Motor	Capacity	Speed	Weight	Dimensions (mm)	Power (kW)	Motor	Speed	Capacity	Weight	Dimensions (mm)	Power (kW)	Motor
BH720	200W	170kg	1700	45	1140 x 270 x 2150	0.2	1700	170	170	170	1140 x 270 x 2150	0.2	1700
BH730	300W	250kg	1700	65	1140 x 270 x 2150	0.3	1700	170	170	170	1140 x 270 x 2150	0.3	1700
BH750	500W	350kg	1700	100	1140 x 270 x 2150	0.5	1700	170	170	170	1140 x 270 x 2150	0.5	1700
BH770	750W	500kg	1700	130	1140 x 270 x 2150	0.75	1700	170	170	170	1140 x 270 x 2150	0.75	1700

**BH750**

Model	Motor	Capacity	Speed	Weight	Dimensions (mm)	Power (kW)	Motor	Speed	Capacity	Weight	Dimensions (mm)	Power (kW)	Motor
BH750	500W	350kg	1700	100	1140 x 270 x 2150	0.5	1700	170	170	170	1140 x 270 x 2150	0.5	1700
BH770	750W	500kg	1700	130	1140 x 270 x 2150	0.75	1700	170	170	170	1140 x 270 x 2150	0.75	1700

**BAHCO**  
www.anaeurope.com



Follow the Fish!





Contact: info@bahco.com / www.bahco.com

PRODUKTEGENSKAPER



Produkt: **BH720**

	20.000 kg	<b>A</b>	880 mm	<b>B</b>	650 mm
<b>C</b>	1785 mm	<b>D</b>	1885 mm	<b>E</b>	645 mm
<b>F1</b>	43 mm	<b>F2</b>	1143 mm	<b>F</b>	129 mm
<b>G</b>	8 mm	<b>H</b>	165 mm	<b>L</b>	70 mm
<b>M</b>	211 mm	<b>X</b>	785 mm	<b>Y</b>	920 mm
	151 kg				

Produkt: **BH730**

	30.000 kg	<b>A</b>	960 mm	<b>B</b>	700 mm
<b>C</b>	1776 mm	<b>D</b>	1810 mm	<b>E</b>	695 mm
<b>F1</b>	140 mm	<b>F2</b>	1020 mm	<b>F</b>	137 mm
<b>G</b>	10 mm	<b>H</b>	200 mm	<b>L</b>	80 mm
<b>M</b>	195 mm	<b>X</b>	855 mm	<b>Y</b>	990 mm
	189 kg				

Produkt: **BH750**

	50.000 kg	<b>A</b>	1.000 mm	<b>B</b>	770 mm
<b>C</b>	1832 mm	<b>D</b>	1855 mm	<b>E</b>	725 mm
<b>F1</b>	173 mm	<b>F2</b>	1013 mm	<b>F</b>	204 mm
<b>G</b>	12 mm	<b>H</b>	243 mm	<b>L</b>	90 mm
<b>M</b>	280 mm	<b>X</b>	905 mm	<b>Y</b>	1070 mm
	309 kg				

