



## BH1EU3000 트롤리 잭, 3T









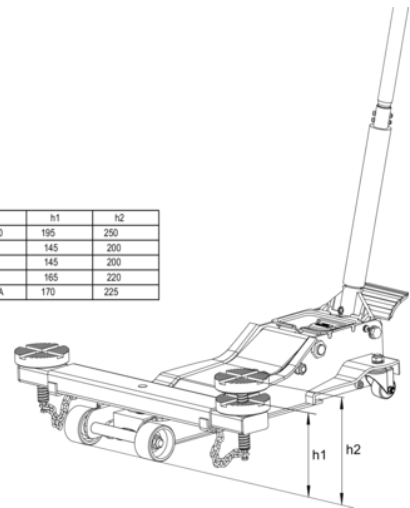



### PRODUCT DETAILS

- 3T 소형 트롤리 잭
- 130mm 높이 입구 및 462mm 높이 도달 가능 높이
- 듀얼 피스톤 시스템으로 7회 펌프 스트로크로 최대 높이 도달 가능
- 나일론 바퀴 장착
- 더스트 커버로 피스톤과 스프링 손상 방지
- 고무 안장으로 차량 표면 보호 및 미끄럼 방지
- 손잡이 폼으로 차체 손상 방지
- 안전 압력 밸브 및 하강 속도 제어 시스템 장착
- CE 인증

Ref.	h1	h2
BH1EU3000	195	250
BH11500	145	200
BH12000	145	200
BH13000	165	220
BH13000QA	170	225



## PRODUCT ATTRIBUTES

Product										
<b>BH1EU3000</b>	3000 kg	130 mm	462 mm	617 mm	6	120 mm	617 mm	340 mm	1400 mm	31 kg

**Follow the Fish!**

