



## 75R3/75R1

### Mechanical Adjustable Free Hand Point Torque Click Wrench with Fixed Ratchet Head



#### PRODUCT DETAILS

- Non-length-dependant so can be used with or without the supplied extension handle (optional on 650 N·m)
- Large dual scale in N·m/ft.lb
- Range covering from 130 to 1,500 N·m/100 - 1100 ft.lb torque values
- Can be used clockwise or anticlockwise by pushing across the square drive of the ratchet head
- Accurate to  $\pm 3\%$  of reading which exceeds the requirements of ISO6789-1:2017
- Exceptionally clear torque signal from the unique mechanism
- Push-through ratchet heads allowing CW and ACW operation
- Extension handle significantly reduces operator effort to achieve high torque values
- All in a portable sturdy blow mould case
- All wrenches come with a factory declaration of conformity traceable to international standards
- ISO 6789
- Made in the UK

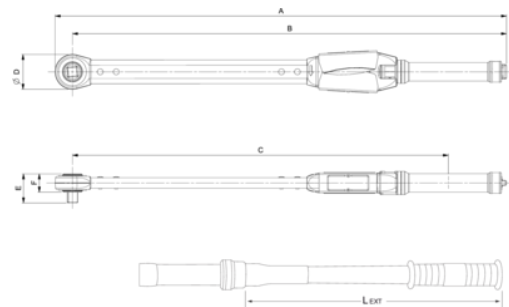
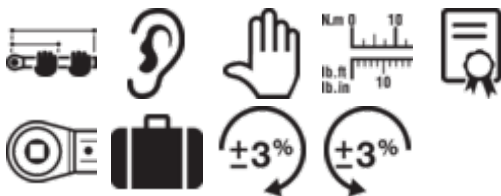





Follow the Fish!







PRODUCT ATTRIBUTES





Product: **75R3-650**

	130-650 Nm		100-480 lb·ft		3/4" in
	5 Nm		5 lb·ft	<b>A</b>	856 mm
<b>B</b>	823 mm	<b>C</b>	713 mm	<b>D</b>	66 mm
<b>E</b>	56 mm	<b>F</b>	30 mm	<b>L<sub>EXT</sub></b>	- mm





Product: **75R3-800**

	200-800 Nm		150-600 lb·ft		3/4" in
	10 Nm		5 lb·ft	<b>A</b>	1037 mm
<b>B</b>	999 mm	<b>C</b>	889 mm	<b>D</b>	75 mm
<b>E</b>	58 mm	<b>F</b>	33 mm	<b>L<sub>EXT</sub></b>	490 mm

Product: **75R3-1000**

	300-1000 Nm		220-750 lb·ft		3/4" in
	10 Nm		5 lb·ft	<b>A</b>	1245 mm
<b>B</b>	1208 mm	<b>C</b>	1097 mm	<b>D</b>	75 mm
<b>E</b>	58 mm	<b>F</b>	38 mm	<b>L<sub>EXT</sub></b>	490 mm

Product: **75R1-1500**

	500-1500 Nm		370-1100 lb·ft		1" in
	10 Nm		10 lb·ft	<b>A</b>	1571 mm
<b>B</b>	1533 mm	<b>C</b>	1422 mm	<b>D</b>	75 mm
<b>E</b>	66 mm	<b>F</b>	38 mm	<b>L<sub>EXT</sub></b>	490 mm

