



8905-TM

Multiplicador de par manual con compensación con brazos de reacción recto y acodado



DETALLES DEL PRODUCTO

- La gama abarca hasta un par máximo de 2700 Nm
- Utilizar siempre con llave dinamométrica (en sentido horario y antihorario) para no exceder el torsión máximo del multiplicador
- Precisión $\pm 4\%$
- Suministrado con brazos de reacción rectos y acodados
- Suministrado en un maletín de plástico
- Fabricado en Reino Unido

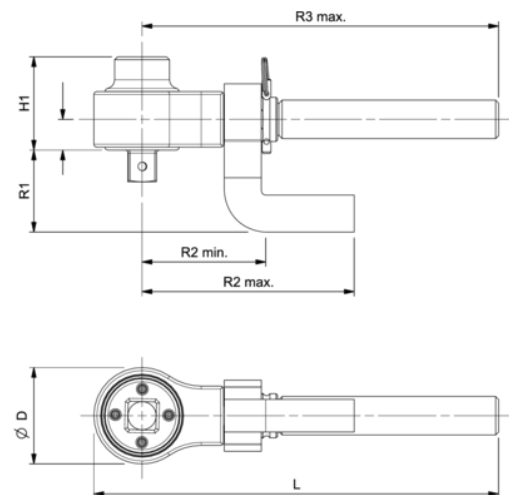









Follow the Fish!



ATRIBUTOS DE PRODUCTO

Producto: 8905-TM

 MAX Nm	1300 N·m		3/4 in		5:1
 MAX Nm	260 N·m	 in	1/2 in	D	108 mm
R3 max mm	344 mm	H1 mm	103 mm	L	210 mm
R2 max mm	212 mm	R2 min mm	140 mm	R1 mm	77 mm
 kg	3.8 kg	 kg	1.06 kg	 kg	1.36 kg
 kg	3.700 kg				

Follow the Fish!

