



749-11

Llave Crowfoot para racores con cuadradillo de 3/8" y 11 mm



DETALLES DEL PRODUCTO

- Llave Crowfoot, racores
- Cuadrado de 3/8"
- El acabado cromado brillante proporciona una superficie de gran calidad

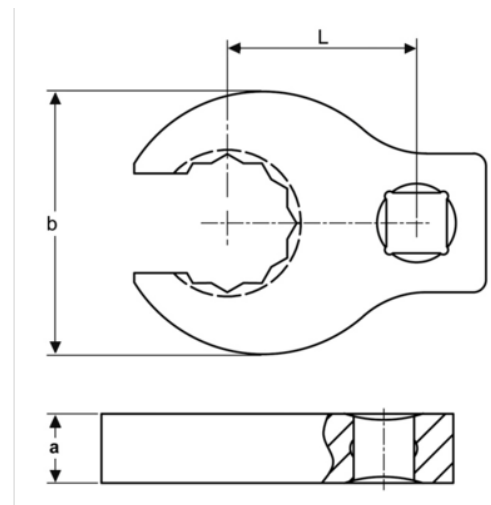
- Acero aleado de alto rendimiento
- Normas: ISO 1174 y DIN 3120.



ATRIBUTOS DE PRODUCTO

Producto			a	b	L	
749-11	3/8 in	11 mm	7 mm	32 mm	26 mm	80 g

Follow the Fish!

