



7809TORX-T55-120

Vaso con punta de 1/2" para tornillos de cabeza TORX® T55, 120 mm



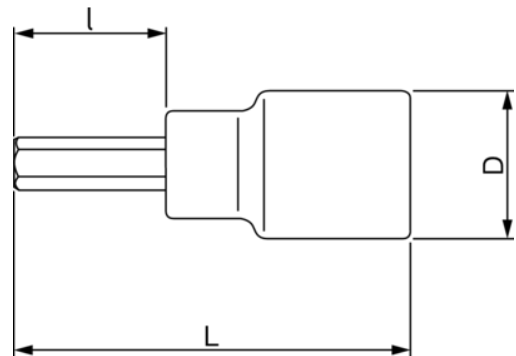

DETALLES DEL PRODUCTO

- Con estriado.
- No se pueden usar con máquinas.
- Acabado pulido fino.
- Acero aleado de alto rendimiento
- Normas: ISO 1174/3120
- SB = Embalaje en blíster con información del producto



ATRIBUTOS DE PRODUCTO

Producto		I	L	D		
7809TORX-T55-120	T55	80 mm	120 mm	22 mm		130 g

Follow the Fish!

