



6709-IP7

Vasos con punta y cuadradillo de 1/4" para tornillos TORX® PLUS® de 7 mm



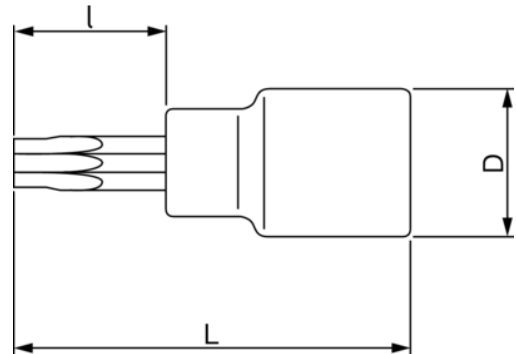

DETALLES DEL PRODUCTO

- Cuerpo estriado para girar tornillos sueltos manualmente.
- No se pueden usar con máquinas.
- Acabado pulido fino.
- Acero aleado de alto rendimiento
- Normas: ISO 1174 y DIN 3120.
- Embalaje en blíster



ATRIBUTOS DE PRODUCTO

Producto		I	L	D		
6709-IP7	IP7	15 mm	37 mm	12 mm		10 g

Follow the Fish!

