



BH3HD12000
Caballete para vehiculos 12T 1P







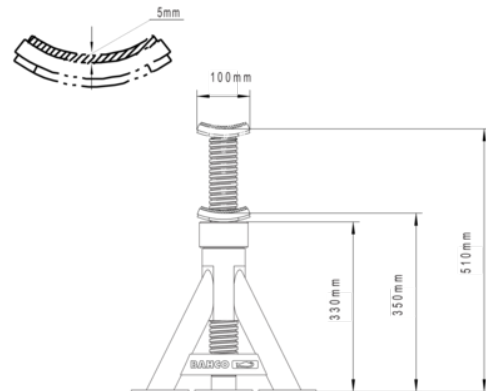

DETALLES DEL PRODUCTO

- Caballete para trabajos pesados 12 T
- Equipado con un sistema de rodamientos en el mango que garantiza un ajuste preciso de la altura
- Altura máxima de 510 mm
- Soporte especial redondo con goma para facilitar y asegurar las operaciones de carga
- Homologación TÜV y certificado GS
- Venta individual



ATRIBUTOS DE PRODUCTO

Producto						
BH3HD12000	12000 kg	350 mm	510 mm	362 mm	329 mm	12.38 kg

Follow the Fish!

