

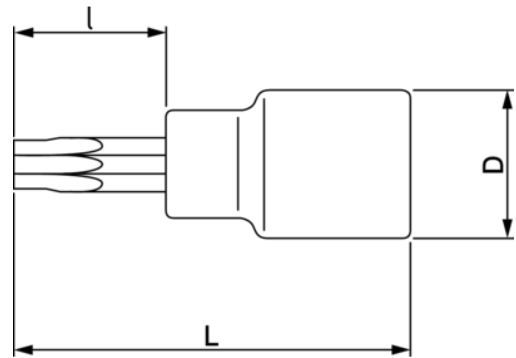





BE51038 Vasos de 1/2" con punta XZN

DETALLES DEL PRODUCTO

- Vasos de 1/2" con puntas para apretar o aflojar tornillos XZN, muy utilizados en los motores
- Cuadradillo: 1/2"
- 6 puntas con la medidas M5, M6, M8, M10, M12 y M14
- Longitud: 140 mm
- Puntas de acero S2 con acabado de cinc fosfatado y mate
- Vasos de acero de cromo vanadio (CrV) con acabado cromado mate



ATRIBUTOS DE PRODUCTO

Producto			I	L	D	
BE51038	1/2 in	M8	100 mm	140 mm	21 mm	115 g

Follow the Fish!

