

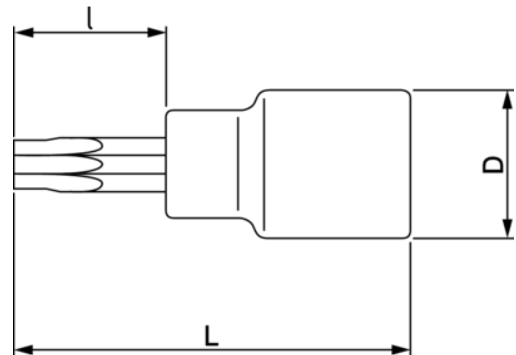

BE510212
Vaso de 1/2" con punta RIBE

DETALLES DEL PRODUCTO

- Vasos de 1/2" con puntas para apretar o aflojar tornillos ribe, muy utilizados en los motores
- Cuadradillo: 1/2"
- 9 puntas con la medidas RM5, RM6, RM7, RM8, RM9, RM10, RM11, RM12 y RM13
- Longitud: 100 mm
- Puntas de acero S2 con acabado de cinc fosfatado y mate
- Vasos de acero de cromo vanadio (CrV) con acabado cromado mate



ATRIBUTOS DE PRODUCTO

Producto			I	L	D	
BE510212	1/2 in	RM12	60 mm	100 mm	21 mm	115 g

Follow the Fish!

