



BE510140

**Vasos de 1/2" con punta TORX®
inviolables**

DETALLES DEL PRODUCTO



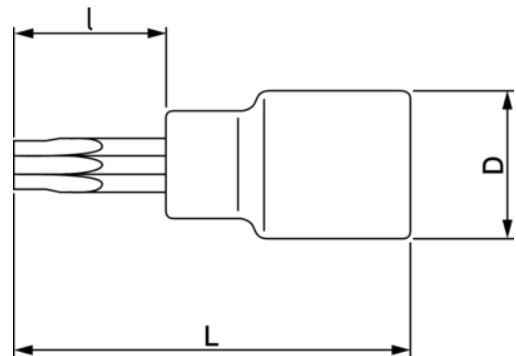

- Vasos de 1/2" con puntas para apretar o aflojar tornillos TORX® inviolables, muy utilizados en los motores
- Cuadradillo: 1/2"
- 9 puntas con la medidas T25, T27, T30, T40, T45, T50, T55, T60 y T70
- Longitud: 100 mm
- Puntas de acero S2 con acabado de cinc fosfatado y mate
- Vasos de acero de cromo vanadio (CrV) con acabado cromado mate



Follow the Fish!



ATRIBUTOS DE PRODUCTO

Producto			I	L	D		
BE510140	1/2 in	TR40	60 mm	100 mm	21 mm	M8	95 g

Follow the Fish!

