



**BE510130**

**Vasos de 1/2" con punta TORX ®  
inviolables**

#### DETALLES DEL PRODUCTO



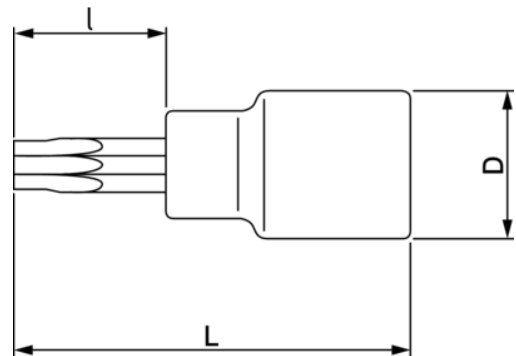

- Vasos de 1/2" con puntas para apretar o aflojar tornillos TORX® inviolables, muy utilizados en los motores
- Cuadradillo: 1/2"
- 9 puntas con las medidas T25, T27, T30, T40, T45, T50, T55, T60 y T70
- Longitud: 100 mm
- Puntas de acero S2 con acabado de cinc fosfatado y mate
- Vasos de acero de cromo vanadio (CrV) con acabado cromado mate



**Follow the Fish!**



## ATRIBUTOS DE PRODUCTO

Producto			<b>I</b>	<b>L</b>	<b>D</b>		
<b>BE510130</b>	1/2 in	TR30	60 mm	100 mm	21 mm	M6	95 g

**Follow the Fish!**

