



SB7809TORX-T40

Vaso con punta con cuadradillo de 1/2" para tornillo de cabeza TORX® T40 en blíster



DETALLES DEL PRODUCTO

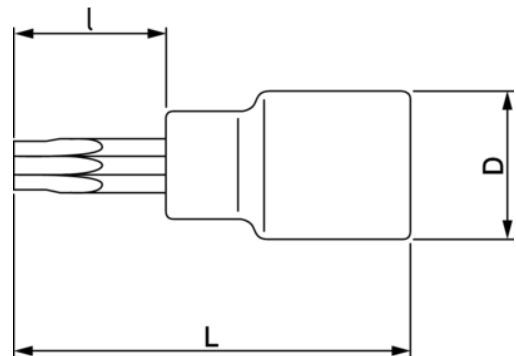

- Cuerpo estriado para girar tornillos sueltos manualmente.
- No se pueden usar con máquinas ni herramientas eléctricas.
- Acabado pulido fino.
- Acero aleado de alto rendimiento
- SB: Embalaje en blíster con información del producto.
- Normas: ISO 1174 y DIN 3120.



Follow the Fish!



ATRIBUTOS DE PRODUCTO

Producto		I	L	D		
SB7809TORX-T40	T40	23 mm	60 mm	22 mm	M 8	80 g

Follow the Fish!

