



**747-2.1/4**



**Llave Crowfoot fija con cuadradillo de 3/8" y 2-1/4"**

### DETALLES DEL PRODUCTO

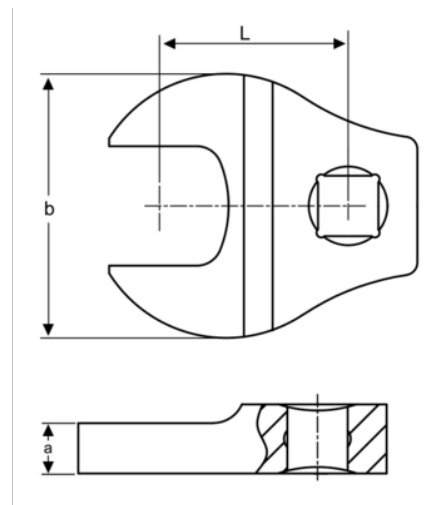
- Llave Crowfoot, boca abierta
- Cuadrado de 3/8"
- El acabado cromado brillante proporciona una superficie de gran calidad
- Acero aleado de alto rendimiento
- Normas: ISO 1174 y DIN 3120.



### ATRIBUTOS DE PRODUCTO

Producto			<b>a</b>	<b>b</b>	<b>L</b>	
<b>747-2.1/4</b>	3/8 in	2.1/4 in	8 mm	110 mm	60 mm	605 g

**Follow the Fish!**

