



**747-1.15/16**

**Llave Crowfoot fija con  
cuadradillo de 3/8" y 1-15/16"**

### DETALLES DEL PRODUCTO

- Llave Crowfoot, boca abierta
- Cuadrado de 3/8"
- El acabado cromado brillante proporciona una superficie de gran calidad
- Acero aleado de alto rendimiento
- Normas: ISO 1174 y DIN 3120.

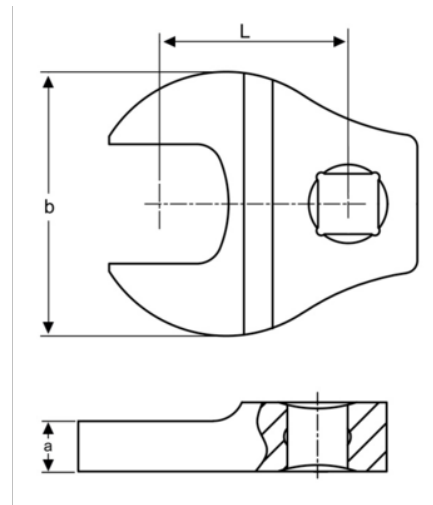

### ATRIBUTOS DE PRODUCTO

Producto			<b>a</b>	<b>b</b>	<b>L</b>	
<b>747-1.15/16</b>	3/8 in	1.15/16 in	8 mm	100 mm	55 mm	500 g

**Follow the Fish!**

