



679-7/16

Llave Crowfoot para racores con cuadradillo de 1/4" y 7/16"

DETALLES DEL PRODUCTO

- Llave Crowfoot, racores
- Cuadrado de 1/4"
- El acabado cromado brillante proporciona una superficie de gran calidad

- Acero aleado de alto rendimiento
- Normas: ISO 1174 y DIN 3120.

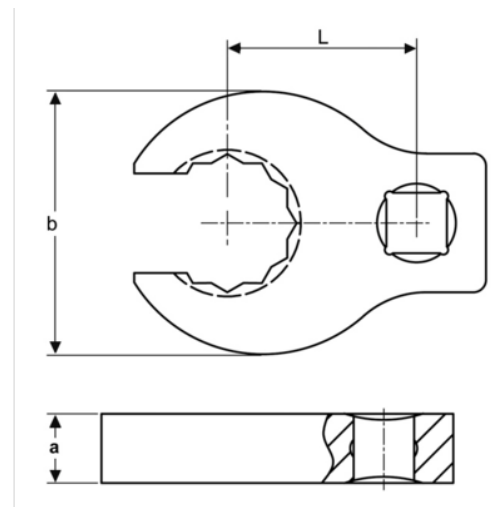

ATRIBUTOS DE PRODUCTO

Producto			a	b	L		
679-7/16	1/4 in	7/16 in	8 mm	28.7 mm	17.5 mm	56 g	56 g

Follow the Fish!

