



SB7409TORX-T40-L

Vaso con punta serie larga y cuadradillo de 3/8" para tornillos TORX® T40 (embalaje en blíster)



DETALLES DEL PRODUCTO

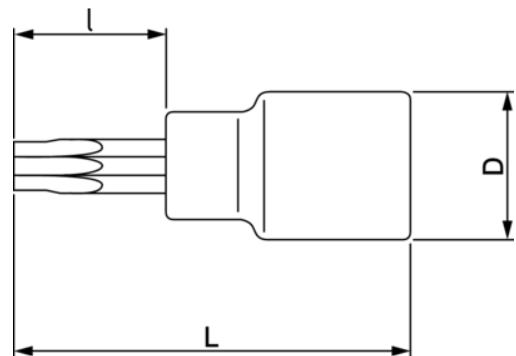

- Cuerpo estriado para girar tornillos sueltos manualmente.
- No se pueden usar con máquinas ni herramientas eléctricas.
- Acabado pulido fino.
- Acero aleado de alto rendimiento
- Normas: ISO 1174 y DIN 3120.



Follow the Fish!



ATRIBUTOS DE PRODUCTO

Producto		I	L	D		
SB7409TORX-T40-L	T40	110 mm	140 mm	19 mm	M8	109 g

Follow the Fish!

