



SB7409TORX-T25

Vaso con punta y cuadradillo de 3/8" para tornillos TORX® T25 (embalaje en blíster)



DETALLES DEL PRODUCTO

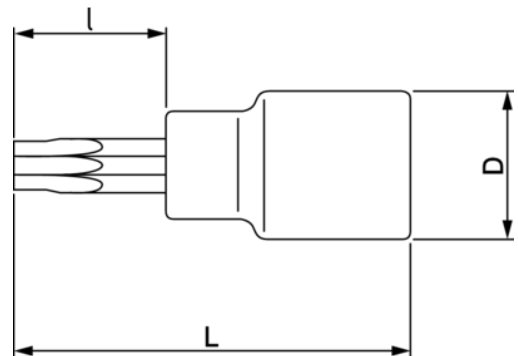

- Cuerpo estriado para girar tornillos sueltos manualmente.
- No se pueden usar con máquinas ni herramientas eléctricas.
- Acabado pulido fino.
- Acero aleado de alto rendimiento
- Normas: ISO 1174 y DIN 3120.



Follow the Fish!



ATRIBUTOS DE PRODUCTO

Producto		I	L	D		
SB7409TORX-T25	T25	17 mm	47 mm	19 mm	M5	54 g

Follow the Fish!

