



SB6709TORX-T9

Vaso con punta y cuadradillo de 1/4" para tornillos TORX® T9 (embalaje en blíster)



DETALLES DEL PRODUCTO

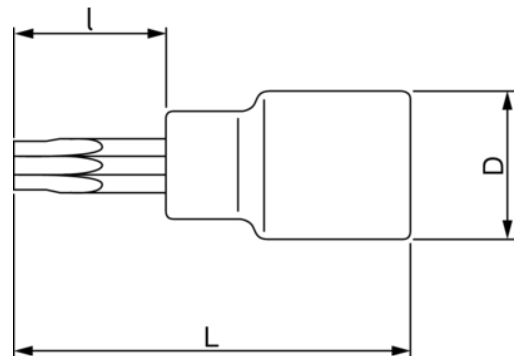

- Cuerpo estriado para girar tornillos sueltos manualmente.
- No se pueden usar con máquinas ni herramientas eléctricas.
- Acabado pulido fino.
- Acero aleado de alto rendimiento
- Normas: ISO 1174 y DIN 3120.



Follow the Fish!



ATRIBUTOS DE PRODUCTO

Producto		I	L	D		
SB6709TORX-T9	T9	16 mm	36 mm	12 mm	-	10 g

Follow the Fish!

