



747-1.5/16

**3/8" gaffel hanefodsnøgle
1-5/16"**





PRODUKTOPLYSNINGER

- Hanefodsnøgle, gaffel
- 3/8" indvendig firkant
- Forkrommet finish giver en overfalde i høj kvalitet

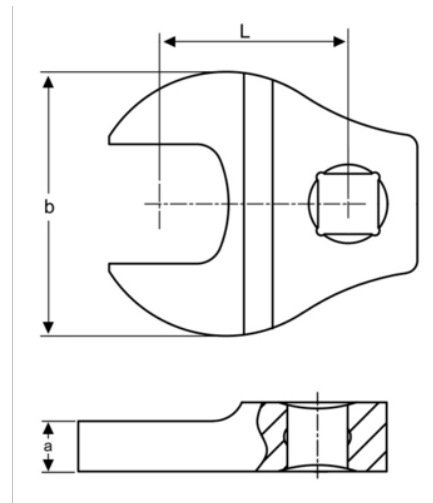
- Højtlegeret stål
- Standarder: ISO 1174, DIN 3120



PRODUKTATTRIBUTTER

Produkt			a	b	L	
747-1.5/16	3/8 in	1.5/16 in	8 mm	65 mm	40 mm	317 g

Follow the Fish!

