



## BH1EU3000 3 tons hydraulisk donkraft.









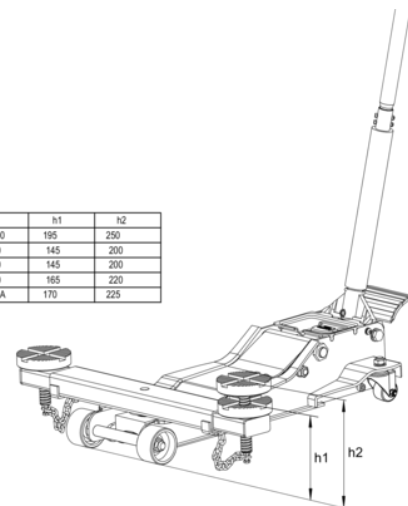



### PRODUKTOPLYSNINGER

- 3T kompakt donkraft
- Manuel hydraulisk løft
- 130 mm indgangshøjde og maksimal opnåelig løftehøjde på 462 mm
- Dobbelt stempelsystem gør det muligt at nå hele højden med syv pumpninger
- Udstyret med hjul af nylon
- Støvdæksel beskytter stemplerne og fjederen mod beskadigelse
- Gummibelagt sadel beskytter køretøjets overflader og forhindrer at det glider
- Hævestang er forsynet med gummi der beskytter køretøjet
- Forsynet med sikkerhedsventil og variabel hastighed ved nedsækning
- CE-certificeret i henhold til 2006/42/EC + BS EN1494

Ref.	h1	h2
BH1EU3000	195	250
BH11500	145	200
BH12000	145	200
BH13000	165	220
BH13000QA	170	225



PRODUKTATTRIBUTTER

Produkt										
<b>BH1EU3000</b>	3000 kg	130 mm	462 mm	617 mm	6	120 mm	617 mm	340 mm	1400 mm	31 kg

