

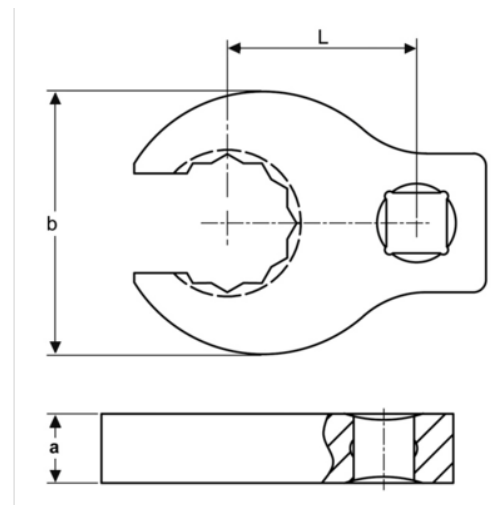





749-2.3/8
3/8"-Kränenfuß-Ringschlüssel
mit Vierkantantrieb, 2.3/8"

PRODUKTDDETAILS

- Kränenfuß-Schraubenschlüssel
- 3/8" Vierkant
- Verchromte und hochglanzpolierte, hochwertige Oberfläche
- Hochleistungs-Stahllegierung
- Geprüft nach: ISO 1174 und DIN 3120



PRODUKTEIGENSCHAFTEN

Produkt			a	b	L	
749-2.3/8	3/8 in	2.3/8 in	11 mm	118 mm	60 mm	1150 g

Follow the Fish!

