

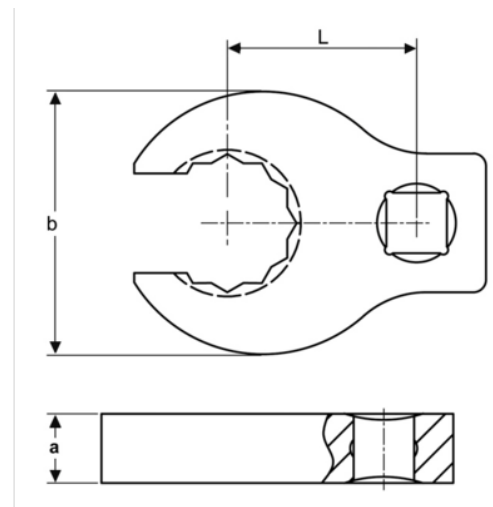





**749-2.3/4**  
**3/8"-Kränenfuß-Ringschlüssel**  
**mit Vierkantantrieb, 2.3/4"**

PRODUKTDDETAILS

- Kränenfuß-Schraubenschlüssel
- 3/8" Vierkant
- Verchromte und hochglanzpolierte, hochwertige Oberfläche
- Hochleistungs-Stahllegierung
- Geprüft nach: ISO 1174 und DIN 3120



PRODUKTEIGENSCHAFTEN

Produkt			<b>a</b>	<b>b</b>	<b>L</b>	
<b>749-2.3/4</b>	3/8 in	2.3/4 in	11 mm	125 mm	70 mm	1400 g

Follow the Fish!

