

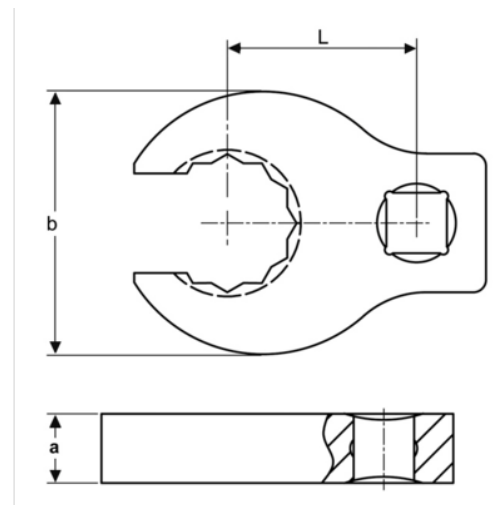





749-1.3/4
3/8"-Kränenfuß-Ringschlüssel
mit Vierkantantrieb, 1.3/4"

PRODUKTDDETAILS

- Kränenfuß-Schraubenschlüssel
- 3/8" Vierkant
- Verchromte und hochglanzpolierte, hochwertige Oberfläche
- Hochleistungs-Stahllegierung
- Geprüft nach: ISO 1174 und DIN 3120



PRODUKTEIGENSCHAFTEN

Produkt			a	b	L	
749-1.3/4	3/8 in	1.3/4 in	11 mm	85 mm	50 mm	247 g

Follow the Fish!

