



2477G-200

Flachrundzangen, gekröpft, Zwei-Komponenten-Griffe, lackiert



PRODUKTDDETAILS

- Flachrundzange, 60° gekröpft, Zwei-Komponenten-Griffe
- Geeignet für das Schneiden von Kupfer-, Eisen- und Fe+-Draht
- Hochleistungs-Stahllegierung
- Polierte und geölte Oberflächen
- Brüniert, rostschutzbehandelt
- 45° gekröpft, Zwei-Komponenten-Griffe
- Schlanke, halbrunde Backen und gezahnte Greifflächen
- Scharfe Kanten zum Schneiden von weichen Materialien wie Kupfer und kunststoffummantelten Drähten

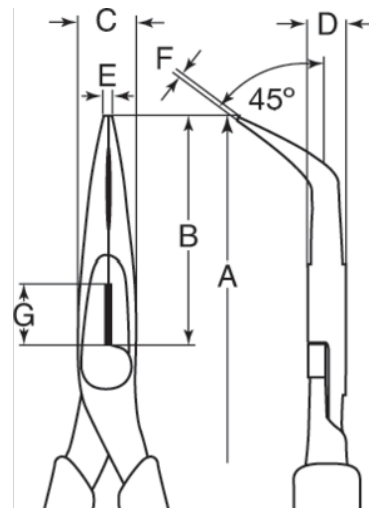





Follow the Fish!







PRODUKTEIGENSCHAFTEN

Produkt: **2477G-160**

A	165 mm	B	48 mm	C	18 mm
D	9 mm	E	3 mm	F	2 mm
G	48 mm	 Cu	3.0 mm	 Fe+	1.5 mm
 Piano	1 mm	 g	160 g		

Produkt: **2477 G-200**

A	210 mm	B	70 mm	C	22 mm
D	11 mm	E	4 mm	F	3 mm
G	70 mm	 Cu	3.0 mm	 Fe+	1.5 mm
 Piano	1 mm	 g	185 g		

