



789-1.7/16



1/2" vidlicový klíč Crowfoot.

PODROBNOSTI O VÝROBKU

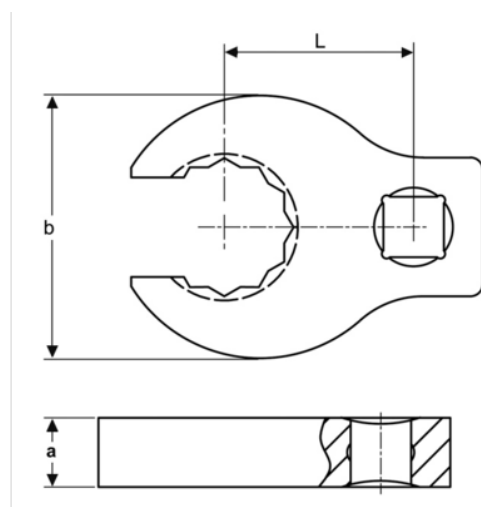
- 1/2" otevřený vidlicový klíč
- Normy: ISO 1174 a DIN 3120
- Materiál: houževnatá legovaná ocel
- Vysokoleštěná chromovaná povrchová úprava pro vysokou kvalitu povrchu



VLASTNOSTI VÝROBKU

Produkt			a	b	L	
789-1.7/16	1/2 in	1.7/16 in	14 mm	70 mm	50 mm	305 g

Follow the Fish!

