



**747-2.5/8**

**Llave Crowfoot fija con cuadradillo de 3/8" y 2-5/8"**



## DETALLES DEL PRODUCTO

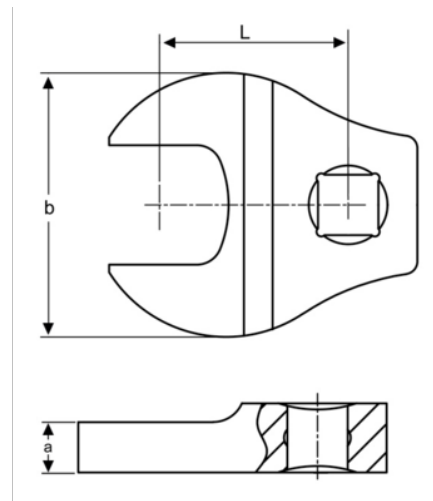

- Llave Crowfoot, boca abierta
- Cuadrado de 3/8"
- El acabado cromado brillante proporciona una superficie de gran calidad
- Acero aleado de alto rendimiento
- Normas: ISO 1174 y DIN 3120.



**Follow the Fish!**



## ATRIBUTOS DE PRODUCTO

Producto			<b>a</b>	<b>b</b>	<b>L</b>	
<b>747-2.5/8</b>	3/8 in	2.5/8 in	8 mm	117 mm	65 mm	645 g

**Follow the Fish!**

