



2427GC

**Alicates ERGO™ de boca
semirredonda y punta curvada 45°,
cromados, con mangos bi-materiales**



DETALLES DEL PRODUCTO

- Mangos ERGO™ bi-componentes: la superficie termoplástica suave en polipropileno resistente proporciona un agarre superior
- Desarrollado de acuerdo con el proceso científico ERGO™
- Capacidad de corte: 2.5 mm a 3 mm de Cu, 1.8 mm de Fe, 1.4 mm a 1.6 mm de Fe +
- Equipado con un muelle de retorno on-off patentado
- Mordazas dentadas y de forma semicircular para agarrar materiales planos y redondos con gran accesibilidad en espacios confinados
- Mordazas dobladas, con bordes de corte endurecidos para cortar alambre blando y duro
- Aleación de alto rendimiento acero
- Acabado cromado, tratamiento anticorrosión
- Normas: ISO 5745
- IP = Embalaje industrial

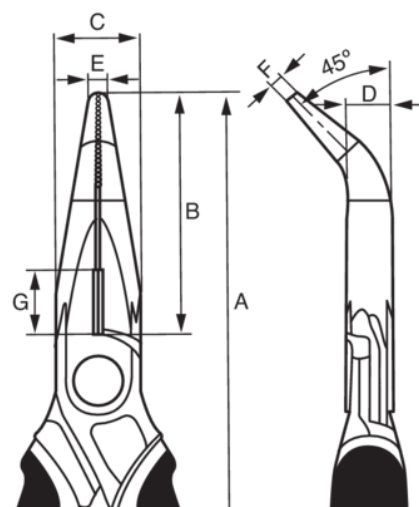





Follow the Fish!







ATRIBUTOS DE PRODUCTO

Producto: **2427 GC-160IP**

A	160 mm	B	46 mm	C	16,5 mm
D	8,9 mm	E	3 mm	F	2.5 mm
G	12 mm	 Cu	3.0 mm	 Fe mm	1.8 mm
 Fe+	1.6 mm	 g	160 g		

Producto: **2427 GC-200IP**

A	200 mm	B	65 mm	C	17 mm
D	9,4 mm	E	3 mm	F	2.5 mm
G	12 mm	 Cu	3.0 mm	 Fe mm	1.8 mm
 Fe+	1.6 mm	 g	170 g		

Follow the Fish!

