



8905-TM/9505-TM

Multiplicador de par manual con compensación con brazos de reacción recto y acodado



DETALLES DEL PRODUCTO

- La gama abarca hasta un par máximo de 2700 Nm
- Utilizar siempre con llave dinamométrica (en sentido horario y antihorario) para no exceder el torsión máximo del multiplicador
- Precisión $\pm 4\%$
- Suministrado con brazos de reacción rectos y acodados
- Suministrado en un maletín de plástico
- Fabricado en Reino Unido

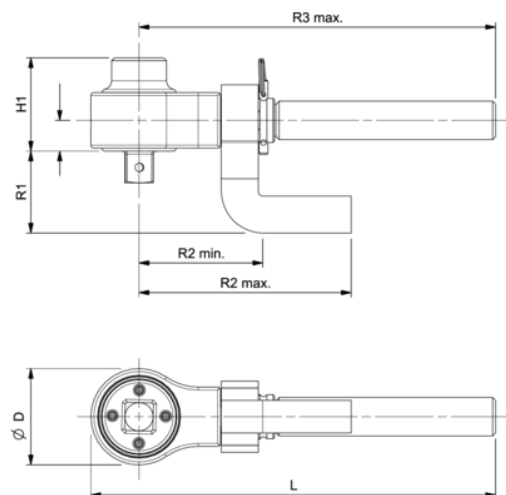









Follow the Fish!











ATRIBUTOS DE PRODUCTO

Producto: 8905-TM

 1300 Nm		3/4 in		5:1
 260 Nm	 in	1/2 in	D	108 mm
R3 max mm	344 mm	H1 mm	103 mm	L 210 mm
R2 max mm	212 mm	R2 min mm	140 mm	R1 mm 77 mm
 3,8 kg	 1.06 kg	 1.36 kg		
 3.700 kg				

Producto: 9505-TM

 2700 Nm		1 in		5:1
 540 Nm	 in	3/4 in	D	108 mm
R3 max mm	344 mm	H1 mm	100 mm	L 210 mm
R2 max mm	212 mm	R2 min mm	140 mm	R1 mm 85 mm
 3,8 kg	 1.06 kg	 1.36 kg		
 3.700 kg				

