



95155B/9526B

**Handmatige momentvermeerderaar
met rechte reactiearm**



PRODUCTGEGEVENS

- Ratelvergrendelsysteem beschikbaar op alle vermeerderaars
- Gradenboog voor gemakkelijk vastdraaien met moment en hoek
- Het maximale outputmoment is 4500Nm
- Altijd gebruiken met momentsleutel (rechtsom en linksom) om te voorkomen dat het maximale moment van de vermeerderaar wordt overschreden
- Nauwkeurigheid $\pm 4\%$
- Een ratelvergrendelsysteem beperkt de krachten die worden gegenereerd tijdens het vastdraaien, waardoor mogelijk wordt wat anders moeilijk, gevaarlijk of zelfs onmogelijk was geweest
- Geleverd met rechte reactiebuis
- Geleverd in draagbare plastic koffer met foambekleding
- Ware 15,5:1 (3000Nm) of 26:1 (4500Nm) momentvermenigvuldigingsverhoudingen waardoor een kleine momentsleutel kan worden gebruikt
- Gemaakt in het Verenigd Koninkrijk

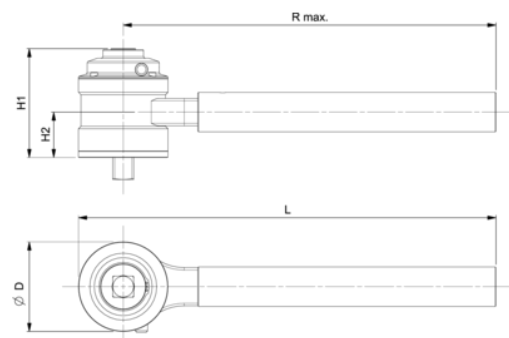







Follow the Fish!









PRODUCTKENMERKEN

Product: **95155B-3000**

 MAX Nm	3000 Nm	 in	1/2 in		15.5:1
 MAX Nm	193 Nm		1 in	D	108 mm
H1 mm	131 mm	H2 mm	55 mm	L	504 mm
R max mm	450 mm	 kg	1.9 kg	 kg	6.1 kg

Product: **9526B-4500**

 MAX Nm	4500 Nm	 in	1/2 in		26:1
 MAX Nm	173 Nm		1 in	D	108 mm
H1 mm	149 mm	H2 mm	55 mm	L	504 mm
R max mm	450 mm	 kg	1.9 kg	 kg	

Follow the Fish!

