



8905-TM/9505-TM

**Handmatige momentvermeerderaar
met haakse en rechte reactiearmen**



PRODUCTGEGEVENS

- Het maximale outputmoment is 2700Nm
- Altijd gebruiken met momentsleutel (rechtsom en linksom) om te voorkomen dat het maximale moment van de vermeerderaar wordt overschreden
- Nauwkeurigheid $\pm 4\%$
- Geleverd met rechte en haakse reactiearmen
- Geleverd in draagbare blaasgegoten koffer
- Gemaakt in het Verenigd Koninkrijk

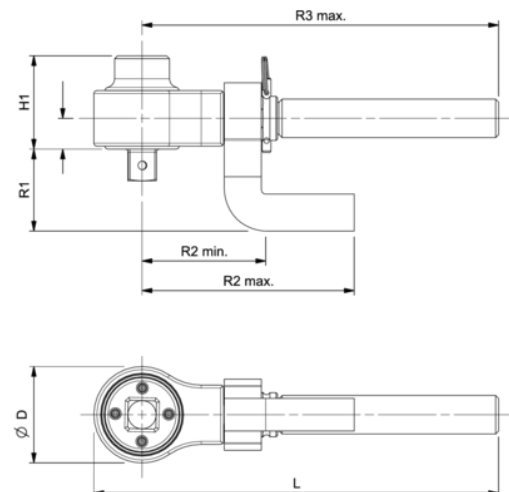









Follow the Fish!











PRODUCTKENMERKEN

Product: 8905-TM

| | | | | | |
|--|---|-----------|---|----------|--------|
|  1300 Nm |  | 3/4 in |  | 5:1 | |
|  260 Nm |  | 1/2 in | D | 108 mm | |
| R3 max mm | 344 mm | H1 mm | 103 mm | L | 210 mm |
| R2 max mm | 212 mm | R2 min mm | 140 mm | R1 mm | 77 mm |
|  3,8 kg |  | 1.06 kg |  | 1.36 kg | |
|  3.700 kg | | | | | |

Product: 9505-TM

| | | | | | |
|--|---|-----------|---|----------|--------|
|  2700 Nm |  | 1 in |  | 5:1 | |
|  540 Nm |  | 3/4 in | D | 108 mm | |
| R3 max mm | 344 mm | H1 mm | 100 mm | L | 210 mm |
| R2 max mm | 212 mm | R2 min mm | 140 mm | R1 mm | 85 mm |
|  3,8 kg |  | 1.06 kg |  | 1.36 kg | |
|  3.700 kg | | | | | |

Follow the Fish!

