



89222CR/96255CR

**Kompakte, handbetätigte
Drehmomentvervielfältiger mit
abgewinkelttem Reaktionsarm**



PRODUKTDDETAILS

- Rücklaufsicherung bei allen Modellen
- Maximales Ausgangsdrehmoment bis zu 7.000 Nm je nach Modell (siehe Tabelle)
- In Verwendung mit Drehmomentschlüssel zu betätigen, um ein Überschreiten des maximalen Ausgangsdrehmoments zu verhindern
- Hohe Genauigkeit: $\pm 4\%$ Toleranz
- Die Rücklaufsicherung erhält die Vorspannung im Gerät, so dass diese nicht bei jedem Hub wieder neu erzeugt werden muss
- Kompakte Bauweise ermöglicht Zugang in beengten Arbeitsbereichen
- Geringes Gewicht trotz hohem Ausgangsdrehmoment
- Inklusive abgewinkelttem Reaktionsarm
- Lieferung im tragbarem Hartschalenkoffer mit Schaumstoffeinlage
- Inklusive Werksprüfzertifikat mit umfangreichen Informationen zu Messwerten und Abweichungen
- Hergestellt in Großbritannien

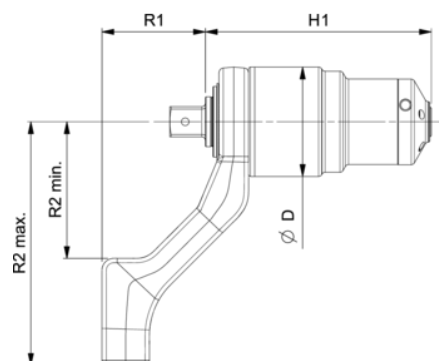







Follow the Fish!









PRODUKTEIGENSCHAFTEN







Produkt: 89222CR-1000

 1000 Nm	 in	1/2 in		22.2:1
 45 Nm		3/4 in	D	52 mm
H1 mm	R1 mm	58 mm	R2 min mm	71 mm
R2 max mm	 kg	0.9 kg	 kg	1.4 kg







Produkt: 9527CR-2000

 2000 Nm	 in	1/2 in		27:1
 74 Nm		1 in	D	72 mm
H1 mm	R1 mm	72 mm	R2 min mm	91 mm
R2 max mm	 kg	0.7 kg	 kg	3.2 kg

Produkt: 9525CR-4000

 4000 Nm	 in	1/2 in		25:1
 160 Nm		1 in	D	92 mm
H1 mm	R1 mm	87 mm	R2 min mm	115 mm
R2 max mm	 kg	1.4 kg	 kg	5.4 kg

Produkt: 96255CR-7000

 7000 Nm	 in	1/2 in		25.5:1
 274 Nm		1.1/2 in	D	119 mm
H1 mm	R1 mm	117 mm	R2 min mm	151 mm
R2 max mm	 kg	2.1 kg	 kg	9.3 kg

