



8905-TM/9505-TM

Mechanische, handbetätigte Drehmomentvervielfältiger mit 2 Abstützvorrichtungen (gerader & abgewinkelter Reaktionsarm)



PRODUKTDDETAILS

- Maximales Ausgangsdrehmoment: 8905-TM: 1.300 Nm und 9505-TM: 2.700 Nm
- In Verwendung mit Drehmomentschlüssel zu betätigen, um ein Überschreiten des maximalen Ausgangsdrehmoments zu verhindern
- Hohe Genauigkeit: $\pm 4\%$ Toleranz
- Inklusive geradem und abgewinkelttem Reaktionsarm für maximale Vielseitigkeit
- Lieferung im robusten Hartschalenkoffer
- Hergestellt in Großbritannien

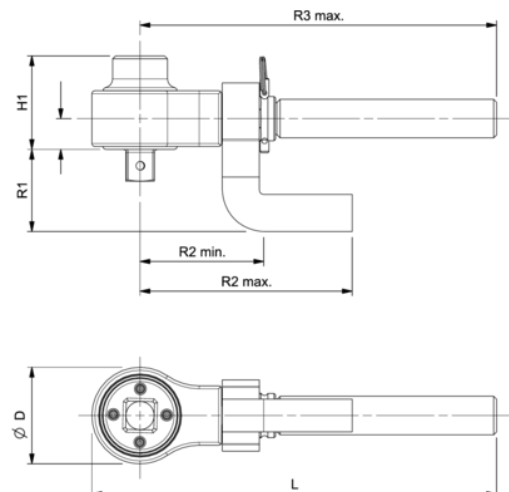









Follow the Fish!











PRODUKTEIGENSCHAFTEN

Produkt: 8905-TM

 1300 Nm		3/4 in		5:1
 260 Nm		1/2 in	D	108 mm
R3 max mm	344 mm	H1 mm	103 mm	L 210 mm
R2 max mm	212 mm	R2 min mm	140 mm	R1 mm 77 mm
 3,8 kg	 1.06 kg	 1.36 kg		
 3.700 kg				

Produkt: 9505-TM

 2700 Nm		1 in		5:1
 540 Nm		3/4 in	D	108 mm
R3 max mm	344 mm	H1 mm	100 mm	L 210 mm
R2 max mm	212 mm	R2 min mm	140 mm	R1 mm 85 mm
 3,8 kg	 1.06 kg	 1.36 kg		
 3.700 kg				

Follow the Fish!

