



## TEA003-TEA030

### Provadores multifuncionais



#### DETALHES DO PRODUTO

- Ferramenta ideal para verificar chaves dinamométricas em oficinas gerais, oficinas auto e linhas de produção
- Unidades de medida: Nm, lbf.ft e lbf.in
- Fácil de usar (interface com quatro botões).
- Pode ser usado no sentido horário, numa gama de temperaturas de -10 °C a +50 °C
- Permite até 10 regulações de torque-alvo e respetivas tolerâncias
- Tomada micro-USB para comunicação bidirecional com um PC ou tablet.
- SEM memória interna, mas pode ser ligado a um PC ou tablet externo para armazenamento de dados
- Modos de funcionamento: pico, 1.º pico e seguimento
- Precisão  $\pm 1\%$  CW ( $\pm 2\%$  quando abaixo de 10% do intervalo para o TEA010 e TEA030A)
- Sinal visual (visor LCD retroiluminado) e audível
- IP40
- Opções de montagem horizontal e vertical
- Alimentado através de tomada micro-USB. Pode também ser alimentado a partir de: powerbanks USB, saída USB de PC e em veículos através de USB. Inclui carregador universal de 110/220 V
- Fornecida em caixa de plástico robusta com espuma
- Fornecida com declaração de conformidade de fábrica, baseada em normas internacionais e marcação CE
- 2014/30/CE, ISO 6789
- Fabricada no Reino Unido

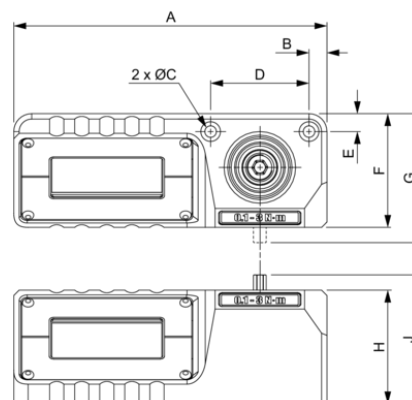







Follow the Fish!









## ATRIBUTOS DO PRODUTO







### Produto: TEA003

 N·m	0.1-3.0 N·m	 lbf·ft	0.074-2.212 lbf·ft	 lbf·in	0.89-26.5 lbf·in
 in			1/4 in	 Nm	0.01 N·m
<b>A</b>	175 mm	<b>B</b>	10 mm	<b>C</b>	6.5 mm
<b>D</b>	55 mm	<b>E</b>	10 mm	<b>F</b>	64 mm
<b>G</b>	N/A mm	<b>H</b>	64 mm	<b>J</b>	72 mm
 kg	1.4 kg				

### Produto: TEA010

 N·m	0.5-10 N·m	 lbf·ft	0.37-7.37 lbf·ft	 lbf·in	4.43-88.5 lbf·in
 in			1/4 in	 Nm	0.01 N·m
<b>A</b>	175 mm	<b>B</b>	10 mm	<b>C</b>	6.5 mm
<b>D</b>	55 mm	<b>E</b>	10 mm	<b>F</b>	64 mm
<b>G</b>	N/A mm	<b>H</b>	64 mm	<b>J</b>	72 mm
 kg	1.4 kg				

### Produto: TEA030A

 N·m	1.5-30 N·m	 lbf·ft	1.11-22.1 lbf·ft	 lbf·in	13.3-265 lbf·in
 in			10 mm	 Nm	0.1 N·m
<b>A</b>	175 mm	<b>B</b>	10 mm	<b>C</b>	6.5 mm
<b>D</b>	55 in	<b>E</b>	10 in	<b>F</b>	64 mm
<b>G</b>	72 in	<b>H</b>	64 mm	<b>J</b>	N/A mm
 kg	1.4 kg				

