



## BH1EU3000 Cric 3 T compact









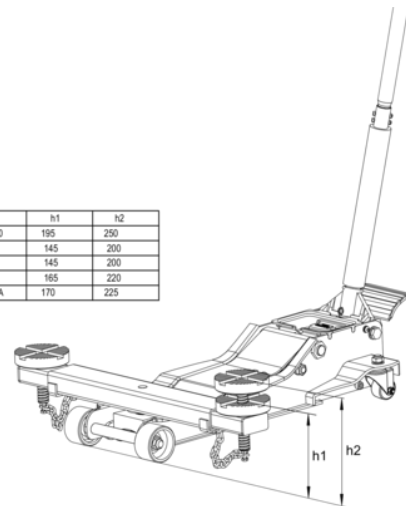



### DÉTAILS SUR LE PRODUIT

- Cric compact 3 T
- Levage hydraulique manuel
- Hauteur d'entrée de 130 mm et hauteur de levage pouvant atteindre 462 mm
- Le système à double piston permet d'atteindre la pleine hauteur en sept coups de levage
- Équipé de roues en nylon
- Protection des pistons et des ressorts contre la poussière
- La selle en caoutchouc protège l'extérieur des véhicules et évite les glissements
- La mousse de la poignée évite les dommages sur la carrosserie
- Équipé d'une soupape de pression de sécurité et d'un système de contrôle de la vitesse de descente
- Certifié CE selon 2006/42/CE et BS EN1494

Ref.	h1	h2
BH1EU3000	195	250
BH11500	145	200
BH12000	145	200
BH13000	165	220
BH13000QA	170	225



## ATTRIBUTS DU PRODUIT

Produit										
<b>BH1EU3000</b>	3000 kg	130 mm	462 mm	617 mm	6	120 mm	617 mm	340 mm	1400 mm	31 kg

**Follow the Fish!**

